

detail of glazing  
see vertical cross-section

**System Schröders**  
Innovation Tür und Tor

Gerhard-Welter-Straße 7; D-41812 Erkelenz

**double leaf steel fire door**  
**E60/EW60**  
**"System Schröders ES-2"**  
horizontal cross-section

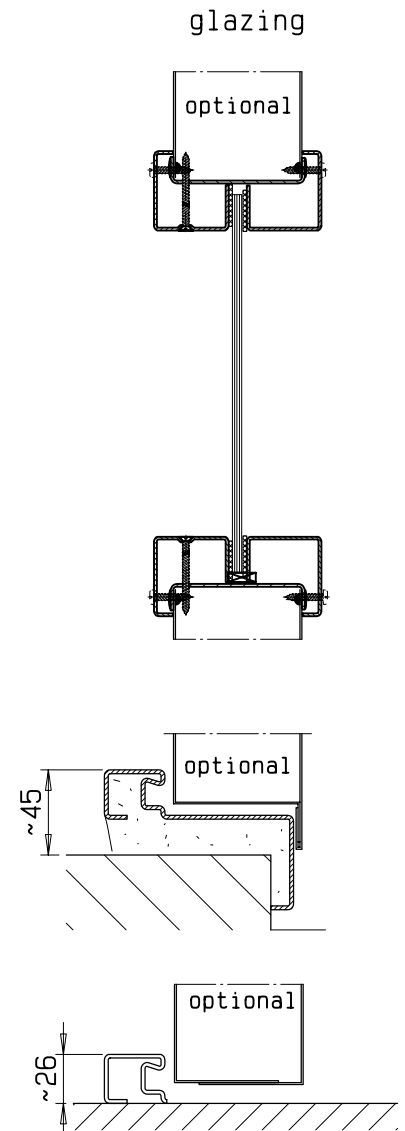
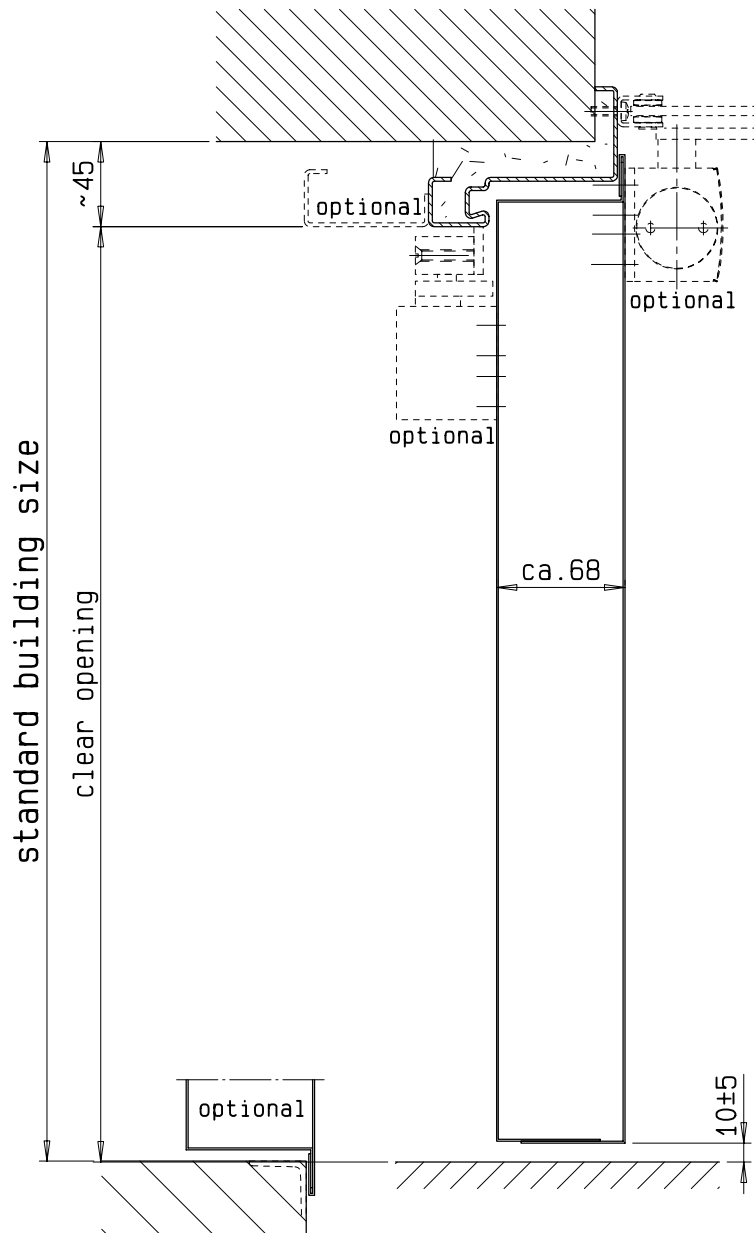

fitting details respectively frames, look at horizontal cross-section

**System Schröders**  
Innovation Tür und Tor

Gerhard-Welter-Straße 7; D-41812 Erkelenz

**double leaf steel fire door**  
**E60/EW60**  
**"System Schröders ES-2"**  
vertical cross-section